

Sir Winston Churchill No.706

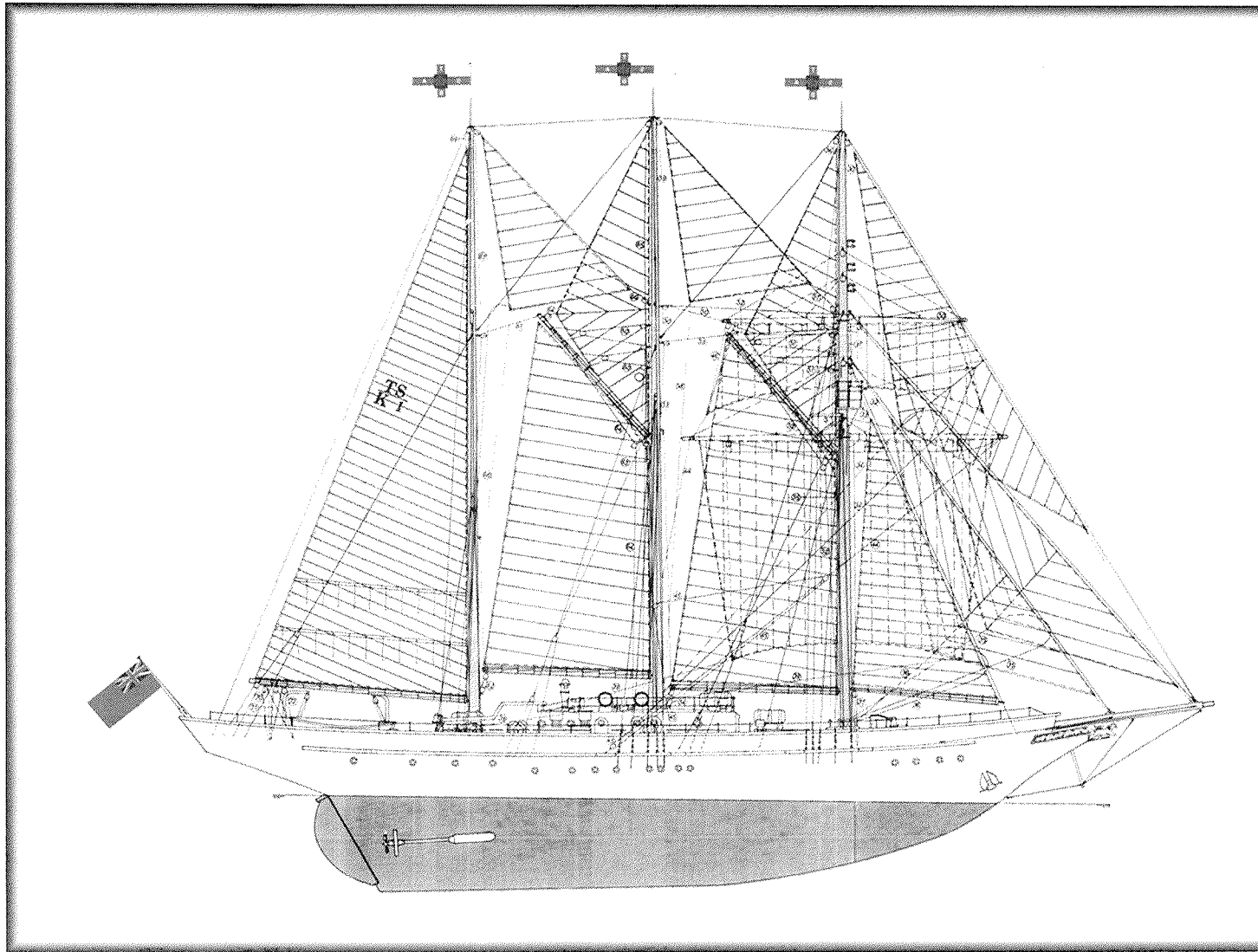

Billing Boats A/S Gejsingvej, 6600 Vejen DK. www.billingboats.com

110899

Fig. 1

Kølen sømmes fast med F230 på en byggeplade (evt. spånplade). Pladen skal være helt lige. Byggepladen findes ikke i byggesættet.

Spanterne pudses og limes på plads. Når limen er tør limes dæk nr. 13 på plads. Spanterne slibes i smig, så de følger dækkets facon (se evt. afsnittet "Træskrog" i hæftet "Byggetips").

Fig. 2

Beklædningen begyndes fra dæk og nedefter med liste nr. 14 (se evt. afsnittet "Træskrog" i hæftet "Byggetips").

Vær opmærksom på, at beklædningen under dæk ender på spant nr. 12, og beklædningen over dæk (skanseklædningen) starter på spant nr. 1 og ender ud over skrogets længde. Længden på skanseklædningen skal tilpasses senere.

Fig. 3

Hækkloids nr. 15 tilpasses og limes på plads, derefter slibes hækkloids og skrog i facon.

Fig. 4

Når begge skrog-halvdele er slebet i facon monteres styr nr. 0a i kølen og skroget limes sammen. Når limen er tør, spartles og slibes

skroget (se evt. afsnittet "Slibning og maling" i hæftet "Byggetips").

Fig. 5

Viser hvorledes kahytten opbygges.

Fig. 6

Viser den næsten færdige kahyt.

Fig. 7-8

Viser opbygning og placering af nedgange, davider mm. Mål findes på hovedtegningen.

Fig. 9

Viser rær og bomme beslået med fittings. De respektive mål findes på hovedtegningen.

Fig. 1

Nail the keel to a building plate, eg. chip board, using F230. The building plate, which is not included in the model kit, should be completely flat and even. Sand the frames and glue them into position. When dry, glue on the deck no. 13. Sand the frames to fit the shape of the deck. (cf. "Wooden hull" section in the Building Tips folder).

Fig. 2

Begin planking, starting at the deck and working downwards, using strip no. 14 (cf. "Wooden hull" section in the Building Tips folder). Make sure that the planking under the deck ends at frame no. 12, and that the planking above the deck (bulwarks) begins at frame no. 1 and extends beyond the length of the hull. The length of the bulwarks is regulated later on in the building process.

Fig. 3

Shape the stern block no. 15 and glue in position. Sand the hull and stern block to shape.

Fig. 4

When both halves of the hull have been sanded in shape, mount steering gear no. 0a in the keel and glue the hull together. When the glue is dry, fill and sand the hull (cf. "Sanding and painting" section in the Building Tips folder).

Fig. 5

Shows the assembly of the cabin.

Fig. 6

Shows the almost completed cabin.

Fig. 7-8

Shows the construction and positioning of the companionways, davits, etc. Dimensions can be seen on the main drawing.

Fig. 9

Shows the yards and booms with fittings. Dimensions can be seen on the main drawing.

Fig. 1

Den Kiel mit F230 auf einer Bauplatte (evt. Spannplatte) festnageln. Die Platte muß völlig eben sein. Die Bauplatte ist nicht im Bausatz enthalten.

Die Spanten sind zu putzen und anzuleimen. Ist der Leim trocken, ist das Deck Nr. 13 anzuleimen. Die Spanten sind schräg zu schleifen, um sie der Deckform anzupassen (siehe ggf. Abschnitt "Holzrumpf" im Heft "Bauratschläge").

Fig. 2

Die Verkleidung ist mit Leiste Nr. 14 vom Deck aus nach unten vorzunehmen (siehe ggf. Abschnitt "Holzrumpf" im Heft "Bauratschläge").

Bitte beachten, daß die Verkleidung unter Deck bei Spant Nr. 12 endet, und die Verkleidung ober Deck (das Schanzkleid) bei Spant Nr. 1 beginnt und über das Bugende hinausragt. Die Länge des Schanzkleides ist später anzupassen.

Fig. 3

Der Heckklotz Nr. 15 ist anzupassen und festzuleimen. Anschließend sind Heckklotz und Rumpf auf gleiche Fassung zu schleifen.

Fig. 4

Sind beide Rumpfhälften auf Fassung geschliffen, ist die Führung Nr. 0a im Kiel und Rumpf zusammenzuleimen. Ist der Leim trocken, ist der Rumpf zu spachteln und zu schleifen (siehe ggf. Abschnitt "Schliff und Anstrich" im Heft "Bauratschläge").

Fig. 5

Zeigt wie die Kajüte aufzubauen ist.

Fig. 6

Zeigt die fast fertige Kajüte.

Fig. 7-8

Zeigt Aufbau und Plazierung der Niedergänge, Davits etc. Die Abmessungen finden sich auf der Hauptzeichnung.

Fig. 9

Zeigt die mit Fittings beschlagenen Rahen und Bäume. Die entsprechenden Abmessungen finden sich auf der Hauptzeichnung.

Fig. 1

Fixer la quille avec des clous F230 sur un bâti de montage. Le bâti, qui n'est pas fourni dans le kit, doit être parfaitement plan. Poncer les couples et les coller en place. Après séchage, coller le pont n° 13. Poncer les couples conformément au pont. (voir "Coques en bois" du manuel d'instructions).

Fig. 2

Commencer le coffrage à partir du pont en allant vers le bas, avec des baguettes n° 14. (voir "Coques en bois" du manuel d'instructions). Vérifier que le coffrage sous le pont se termine au couple n° 12 et que le coffrage au dessus du pont (bastingage) commence au couple n° 1 et s'étend tout le long de la coque. La longueur du bastingage sera ajustée plus tard dans la construction.

Fig. 3

Former le bloc arrière n° 15 et le coller en place. Poncer la coque et le bloc arrière.

Fig. 4

Après avoir poncé les 2 moitiés de la coque, mettre en place le gouvernail n° 0a dans la coque et coller les demi-coques ensemble. Après séchage, mastiquer et poncer la coque.

(voir "Ponçage et peinture" du manuel d'instructions").

Fig. 5

Montre l'assemblage de la cabine.

Fig. 6

Montre la cabine complète.

Fig. 7-8

Montrent la construction et le positionnement des capots, bossoirs, etc. Les dimensions sont visibles sur le plan principal.

Fig. 9

Montre les vergues et tangons avec les accastillages. Les dimensions sont visibles sur le plan principal.

Fig. 1

Spijker de kiel met F230 op een bouwplaat (evt. spaanplaat) vast. De plaat moet helemaal rechtlopen. De bouwplaat maakt geen deel uit van de bouwset.

Schuur de spanten en lijm ze op hun plaatsen. Als de lijm droog is, dek nr. 13 op z'n plaats lijmen. Schuur de spanten schuin af zodat ze de vorm van het dek volgen (lees evt. het stuk "Houten rompen" in de folder "Bouwtips").

Fig. 2

Breng de beplanking aan, beginnend bij het dek met strip nr. 14 (lees evt. het stuk "Houten rompen" in de folder "Bouwtips").

Let erop dat de beplanking onder het dek op spant nr. 12 eindigt en de bekleding boven het dek (de schansbeplanking) op spant nr. 1 begint en buiten het einde van de romp eindigt. De lengte van de schansbeplanking wordt later aangepast.

Fig. 3

Pas het achterstevenblok nr. 15 aan en lijm het op z'n plaats, schuur daarna het achterstevenblok en de romp in vorm.

Fig. 4

Monteer als beide helften van de romp in vorm geschuurd zijn, de geleider nr. 0a in de kiel en lijm de romp samen. Plamuur en schuur de romp als de lijm droog is (lees evt. het stuk "Schuren en verven" in de folder "Bouwtips").

Fig. 5

Toont hoe de kajuit wordt opgebouwd.

Fig. 6

Toont de kajuit als hij bijna klaar is.

Fig. 7-8

Toont de opbouw en plaatsing van trappen, gieken enz. De afmetingen staan op de hoofdtekening.

Fig. 9

Toont de ra's en bomen met beslagen. De verschillende afmetingen staan op de hoofdtekening.

Fig. 1

Fijar la quilla con los clavos n.º F230 en una placa de construcción (p.ej. una placa de virutas). Es preciso que la placa esté completamente plana. La placa no está comprendida en el juego de construcción. Esmerilar las cuadernas y montarlas con cola. Cuando esté seca la cola se monta la cubierta n.º 13.

Las cuadernas se biselan a la forma de la cubierta (véa el párrafo "Cascos de madera" en el folleto "Consejos de construcción").

Fig. 2

Comenzar el trabajo de forro trabajando de la cubierta hacia abajo con el listón n.º 14 (véa el párrafo "Cascos de madera" en el folleto "Consejos de construcción").

Prestar atención a que el revestimiento bajo la cubierta termina a la cuaderna n.º 12 y que el revestimiento sobre la cubierta (la regala) comienza a la cuaderna n.º 1 y termina excediendo la longitud del casco. La longitud de la regala debe ser ajustada posteriormente.

Fig. 3

Ajustar el taco de popa n.º 15 y montarla con cola. Luego se esmerilan el taco de popa y el casco.

Fig. 4

Una vez formadas las piezas de casco por esmerilado, se monta la guía n.º 0a a la quilla. Luego se juntan las piezas de casco con cola. Cuando esté seca la cola, el casco es plasteado y esmerilado (véa el párrafo "Esmerilado y pintado" en el folleto "Consejos de construcción").

Fig. 5

Muestra el procedimiento de la construcción del camarote.

Fig. 6

Muestra el camarote casi terminado.

Fig. 7-8

Muestra la construcción y colocación de bajadas, pescantes, etc. Las medidas se desprenden de la ilustración principal.

Fig. 9

Muestra las vergas y botavaras montadas con herrajes. Las medidas respectivas se desprenden de la ilustración principal.

Fig. 1

Fissate la chiglia con dei chiodini su un asse di montaggio, p.e. di truciolare, (non contenuto nella scatola di montaggio), avendo cura che essa sia perfettamente piana. Levigate accuratamente le ordinate ed incollatele seguendo le istruzioni del disegno. Solo quando la colla sarà perfettamente asciutta potete procedere con i lavori, incollando la coperta Nr. 13. Osservate che le ordinate devono essere levigate in forma per adattarle meglio alla sagomatura della coperta. (Confrontate anche il capitolo "Scafo in legno" nell'apposito opuscolo "Consigli per il montaggio").

Fig. 2

Il fasciame, ricavato dal listello Nr. 14, viene posato dal basso verso l'alto. (Confrontate anche il capitolo "Scafo in legno" nell'apposito opuscolo "Consigli per il montaggio"). Osservate che il fasciame inferiore finisce al di sotto della coperta, in particolare all'altezza dell'ordinata Nr. 12, mentre il fasciame da mettere in opera al di sopra della coperta (ovvero il parapetto di murata) inizia all'altezza dell'ordinata Nr. 1, sporgendo al di là dell'estremità della prua. La lunghezza del parapetto di murata si adatta in un secondo momento.

Fig. 3

Adattate il blocchetto di legno che forma la poppa ed incollatelo. Successivamente dovete levigare il blocchetto e lo scafo stesso, per dare alla poppa la giusta sagomatura.

Fig. 4

Una volta sagomate le due metà dello scafo, potete incollare l'opportuna guida Nr. 0a sia alla chiglia che allo stesso scafo. Solo quando la colla sarà perfettamente asciutta si può stuccare lo scafo, per sottoporlo poi ad un'accurata levigata. Confrontate anche il capitolo "Smerigliare e verniciare" nell'apposito opuscolo "Consigli per il montaggio").

Fig. 5

Questa figura informa su come montare la cabina.

Fig. 6

Questa figura mostra la cabina quasi pronta.

Fig. 7-8

Questa figura mette in evidenza la corretta posizione dei boccaporti, dei buttafuori e degli altri accessori. Per le corrette dimensioni è

opportuno confrontare con il disegno principale.

Fig. 9

Questa figura mostra i pennoni e gli alberi completati con tutti i vari accessori. Per le corrette dimensioni è opportuno confrontare con il disegno principale.

Fig. 1

A quilha é pregada com F230 numa placa de construção (eventualmente placa de aglomerado). A placa tem de ser inteiramente plana. A placa de construção não está incluída no conjunto.

As peças de armação são polidas e lixadas, para encaixar. Quando a cola estiver seca, colar o deck nº 13. As peças de armação são chanfradas, de modo a seguirem a forma do deck. (ver eventualmente a seção “Casco de Madeira” na revista “Dicas de Construção”).

Fig. 2

Começa-se a fazer o revestimento do deck para baixo, com a tira nº 14, (ver eventualmente a seção “Casco de Madeira” na revista “Dicas de Construção”).

Esteja atento para que o revestimento sob o deck termine na peça de armação nº 12, e que o revestimento em cima do deck (o baluarte) comece na peça de armação nº 1 e termine fora do casco. O comprimento do baluarte deve ser adaptado posteriormente.

Fig. 3

O bloco de popa nº 15 é adaptado e colado no lugar. Depois o bloco de popa e o casco são lixados em forma.

Fig. 4

Quando ambas as metades do casco estiverem lixadas em forma, monta-se o timão nº 0a na quilha, e cola-se o casco. Quando a cola estiver seca, encher cavidades e lixar o casco, (ver eventualmente a seção “Lixação e pintura” na revista “Dicas de Construção”).

Fig. 5

Mostra como a cabine é construída.

Fig. 6

Mostra a cabine quase pronta.

Fig. 7-8

Mostra a construção e a localização das escadarias, turcos, etc. As medidas encontram-se na planta principal.

Fig. 9

Mostra vergas e botalós com ferragens. As respectivas medidas encontram-se na planta principal.

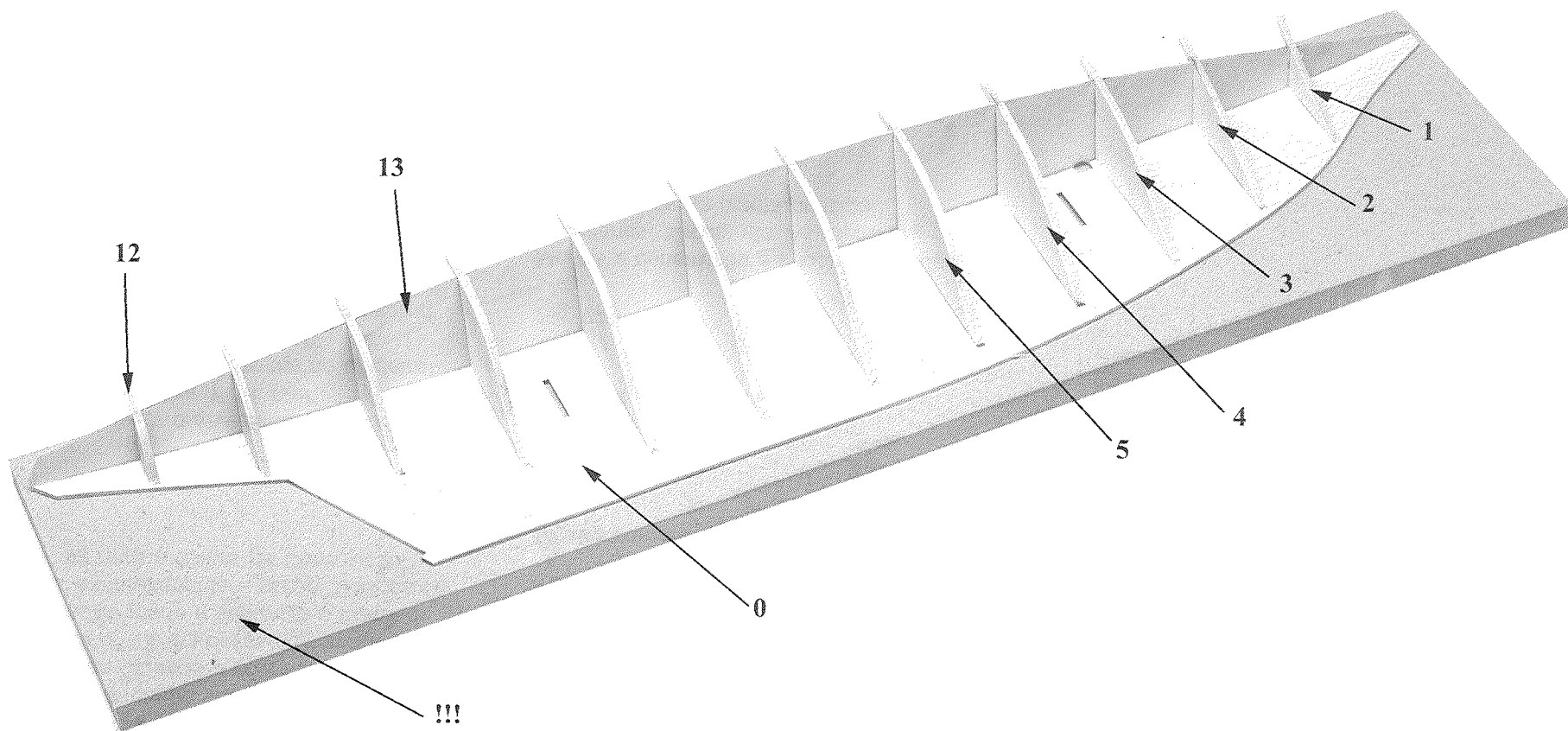

FIG.1

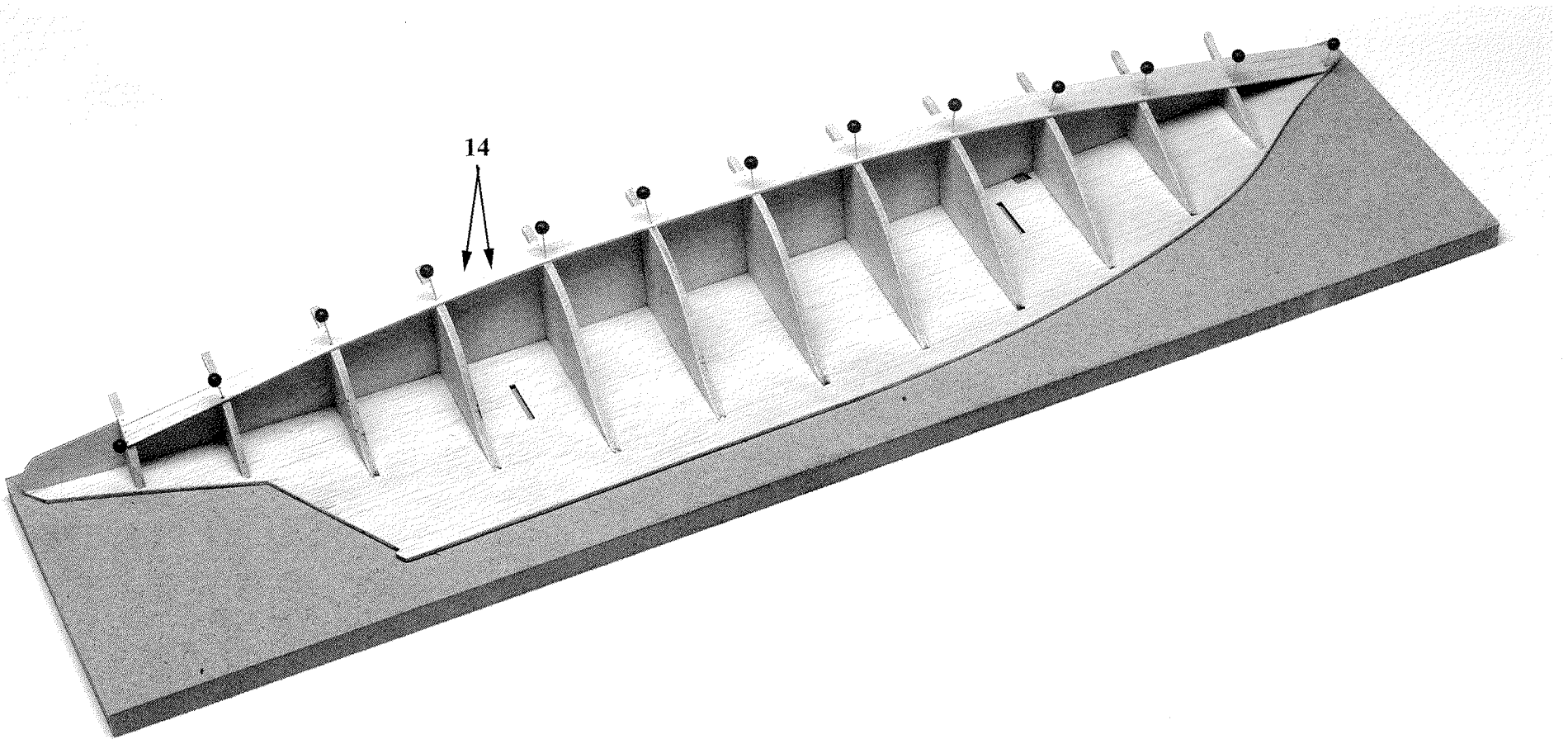

FIG.2

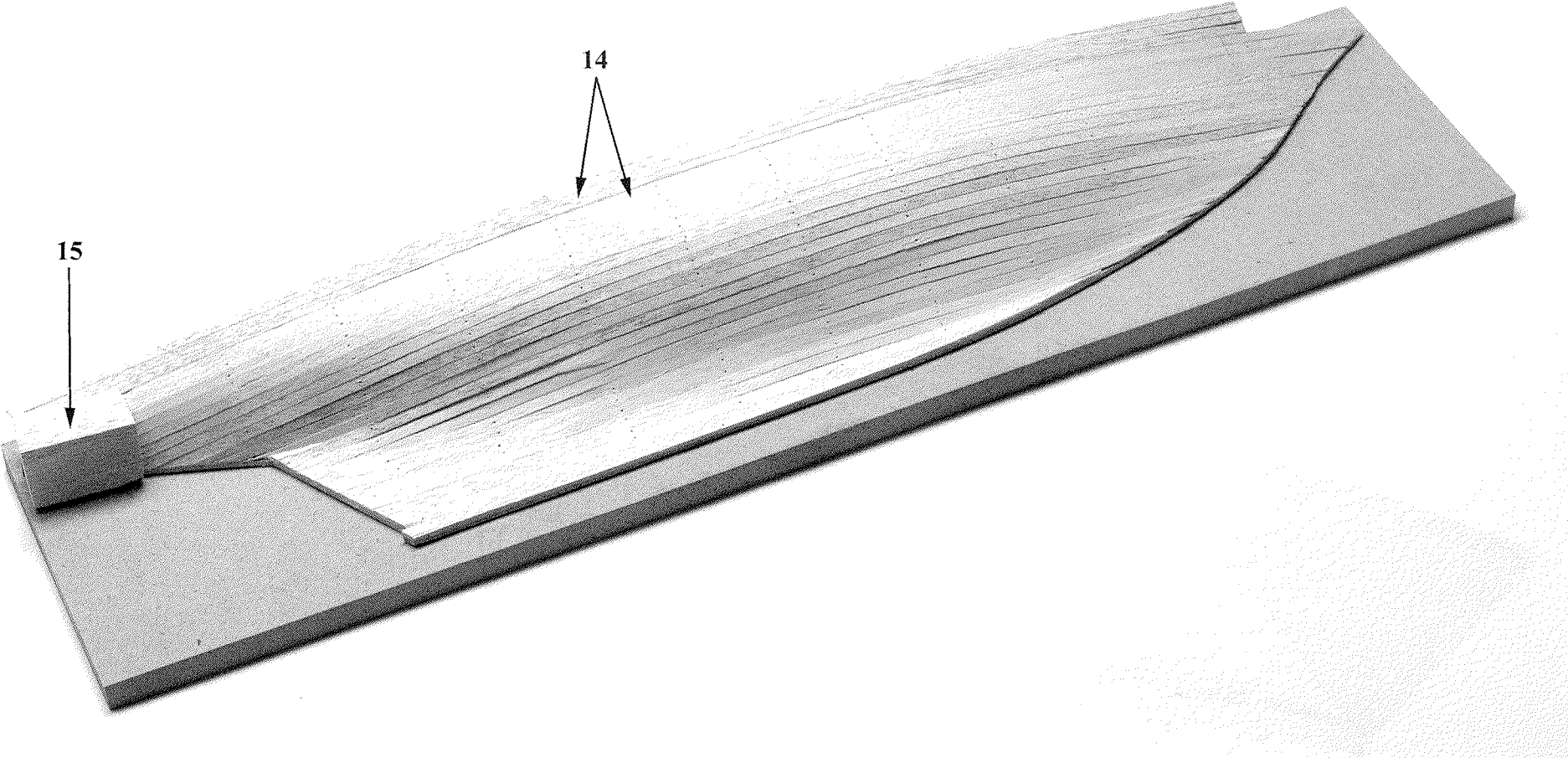

FIG.3

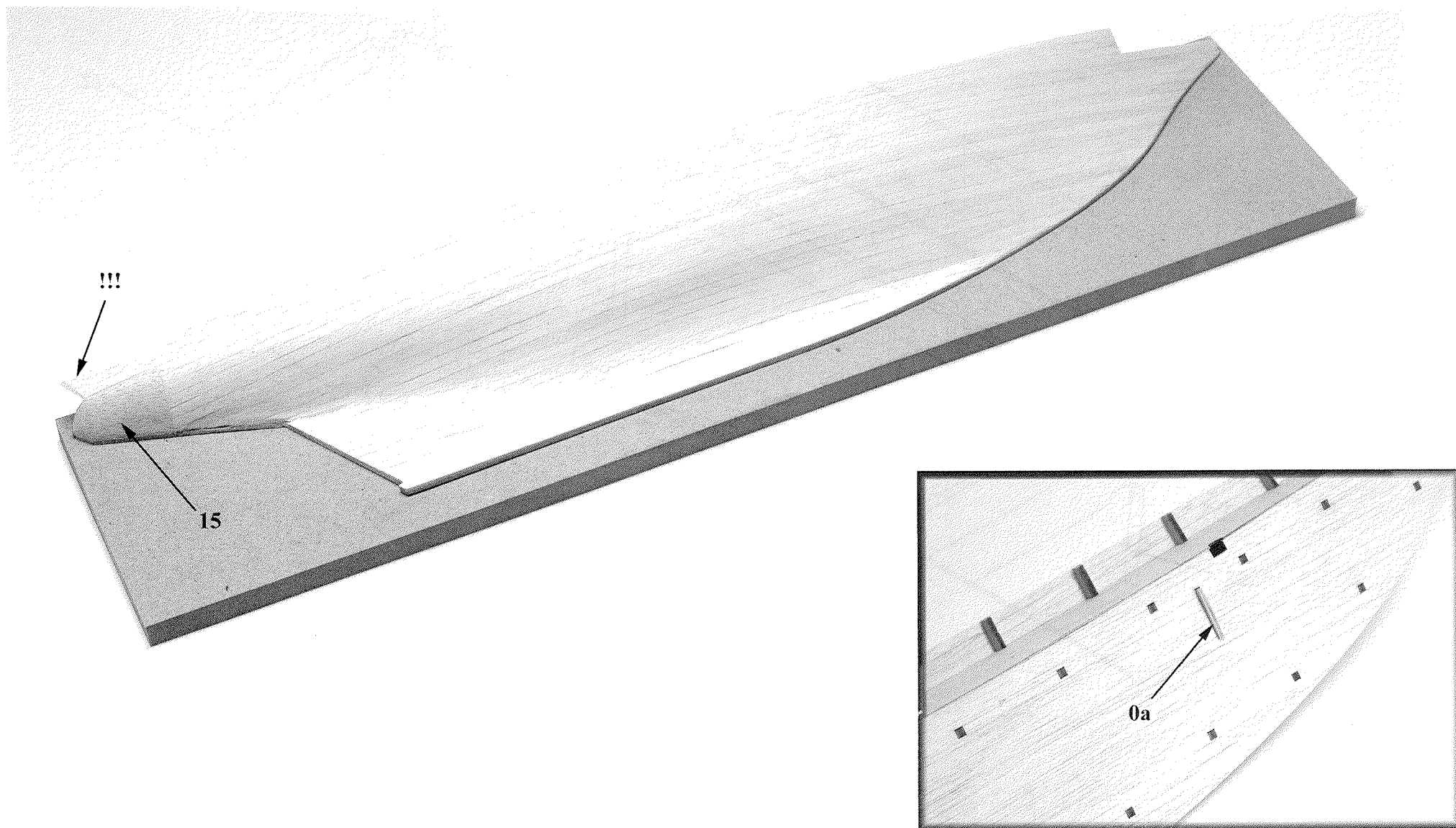

FIG.4

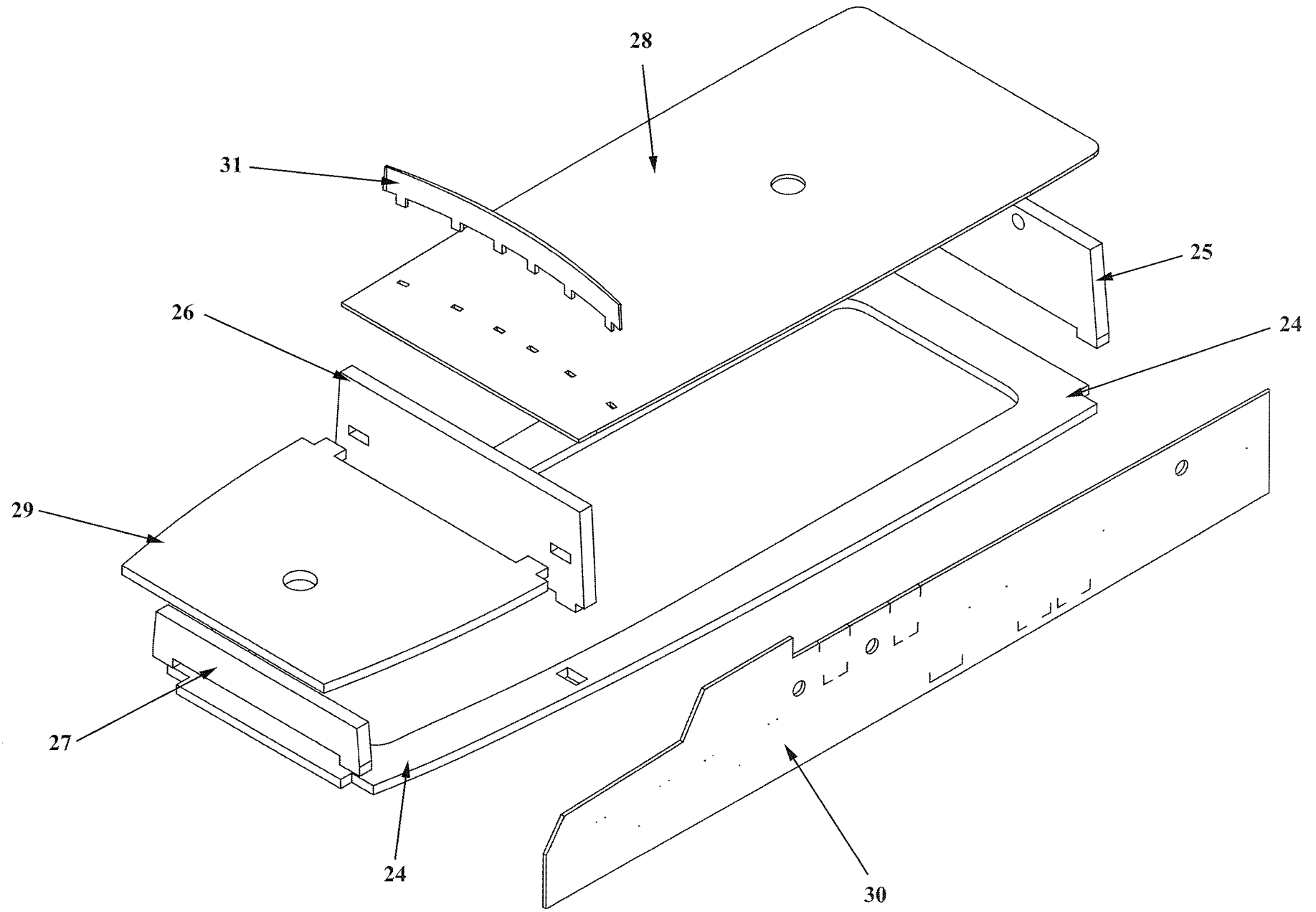

FIG.5

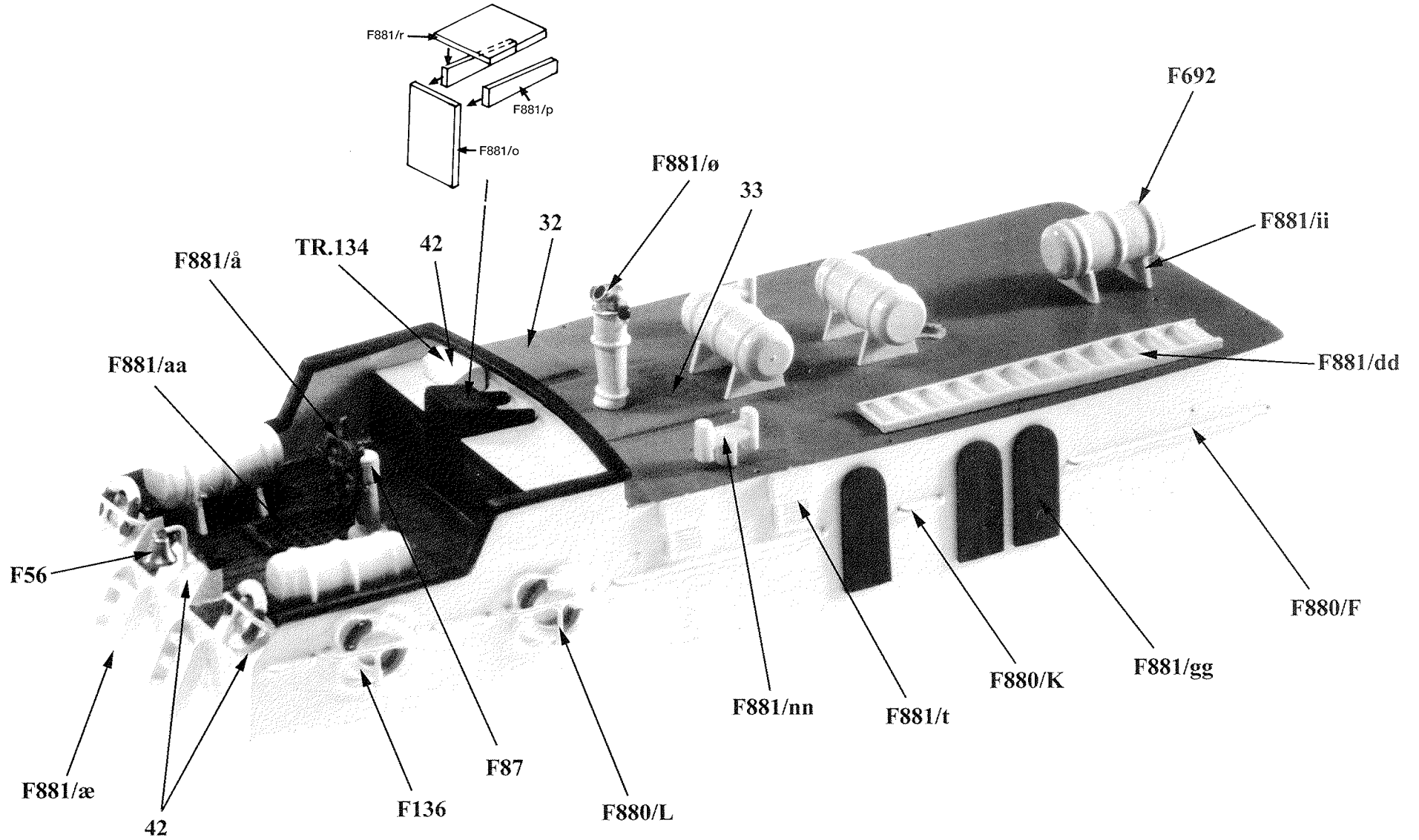

FIG.6

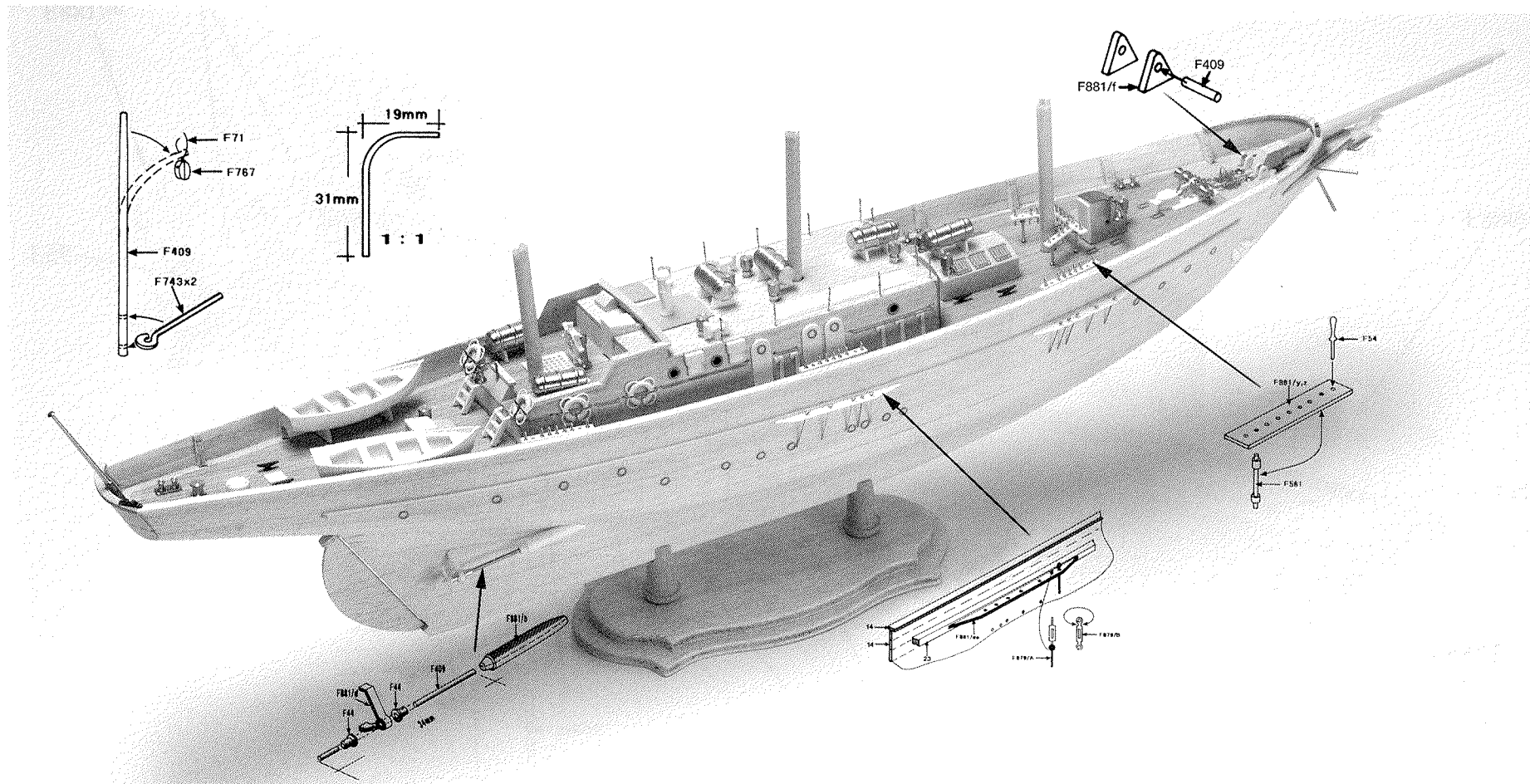

FIG.7

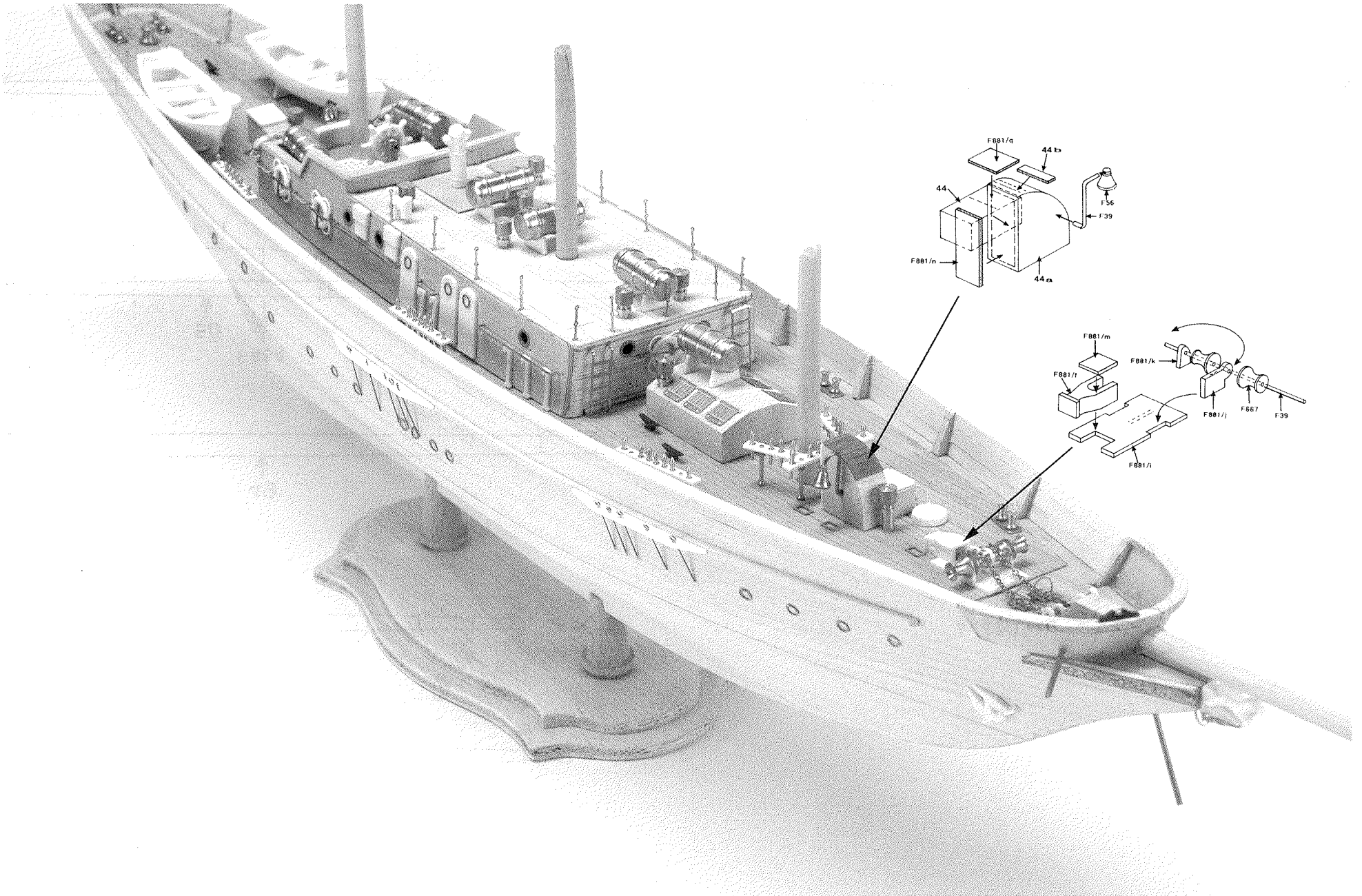

FIG.8

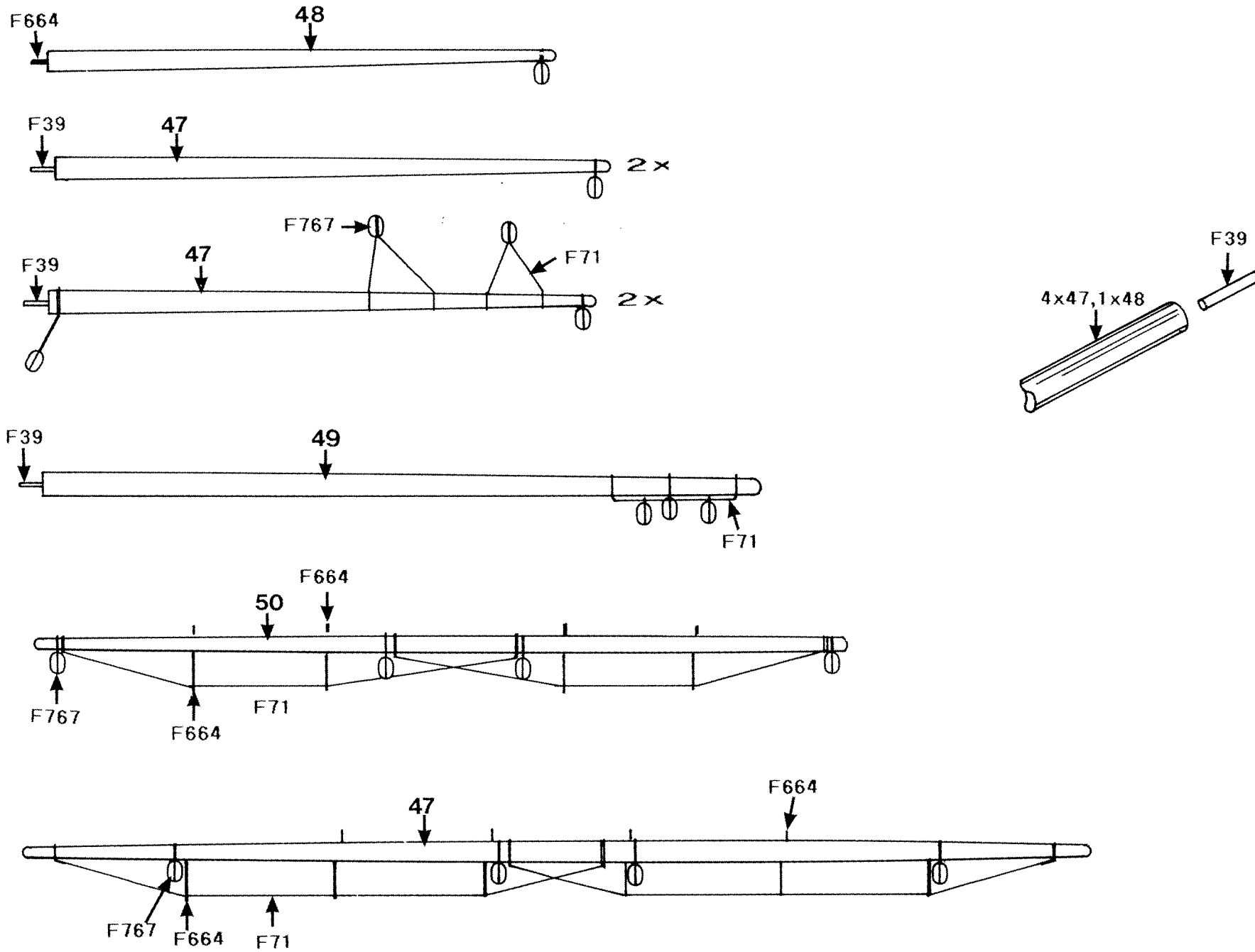

















FIG.9



Symboler  = Rigningsnummer
 = Farvenummer
 = Bejdse



Symbols  = Rigging No.
 = Colour No.
 = Stain



Zeichen  = Takel Nr.
 = Farben Nr.
 = Beize

Symboles  = Greement no.
 = Couleur no.
 = Mordant

Symbolen  = Tuigage Nr.
 = Kleur Nr.
 = Beits

Símbolo  = Oparejo Nr.
 = Color Nr.
 = Mordiente

Segno  = Attrezzatura N°
 = Colore N°
 = Inchiostro tint.

Simbolos  = Cordame n°
 = Cõr n°
 = Tintura

Til denne model er mahogni bejdse og farver (Humbrol) med følgende numre nødvendige:

For this model is mahogany stain and colours (Humbrol) with the following numbers should be used:

Für dieses Modell sind Mahagoni Beize und Farben (Humbrol) mit den folgenden Nummern notwendig:

Pour ce modèle, le mordant et les couleurs (Humbrol) avec les numéros suivants doivent être employés:

Voor dit model zijn kleuren (Humbrol) met de volgende nummers nodig:

Para est modelo se necesitan mordiente et colores (Humbrol) con los siguientes números:

Per questo modello occorrono inchiostro tinteggiatore "mogano" e colori (Humbrol) con questi numeri:

Pinte o modelo com tintura cõr Mogno e as cõres sugeridas da Billing Boats (ou Humbrol):

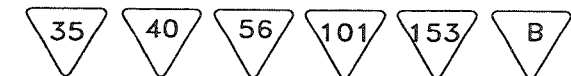

2141L

22

0

22

0



0a

27

26

25

2142L

11

2

11

10

8

7

7

12

9

4

3

5

6

1

2

12

5

6

4

3

9

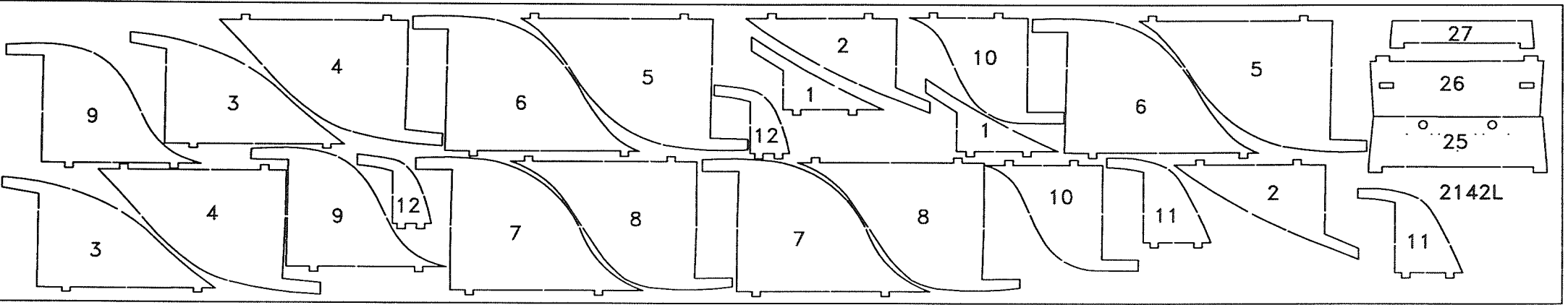
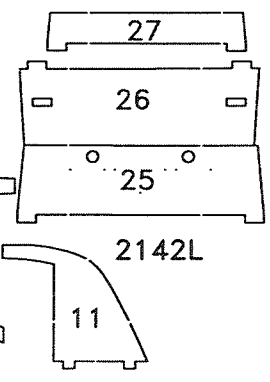

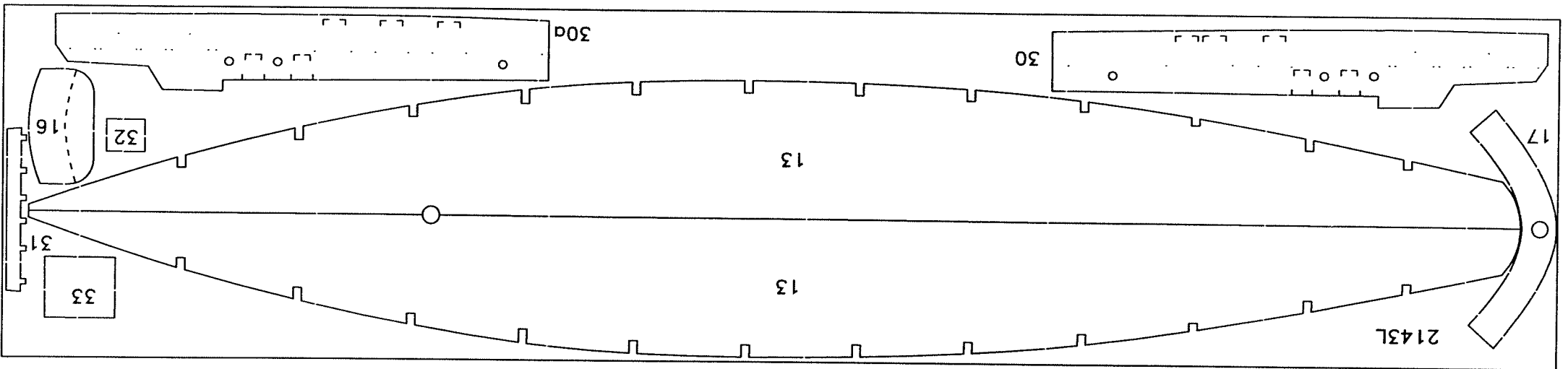
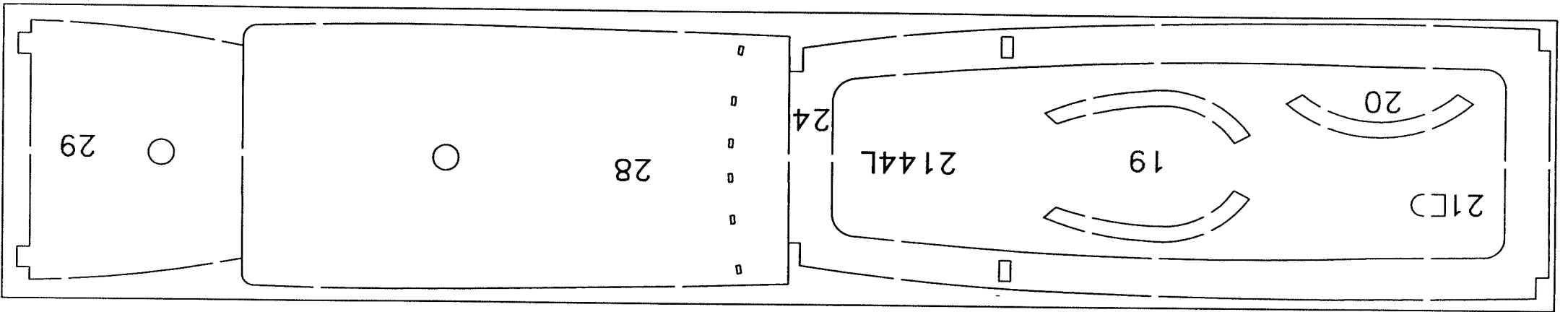

F879

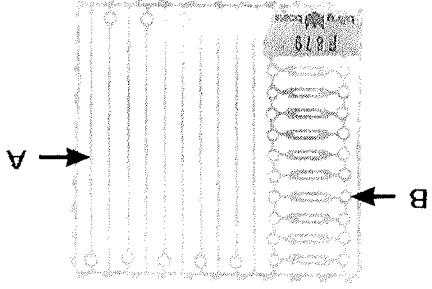

F880

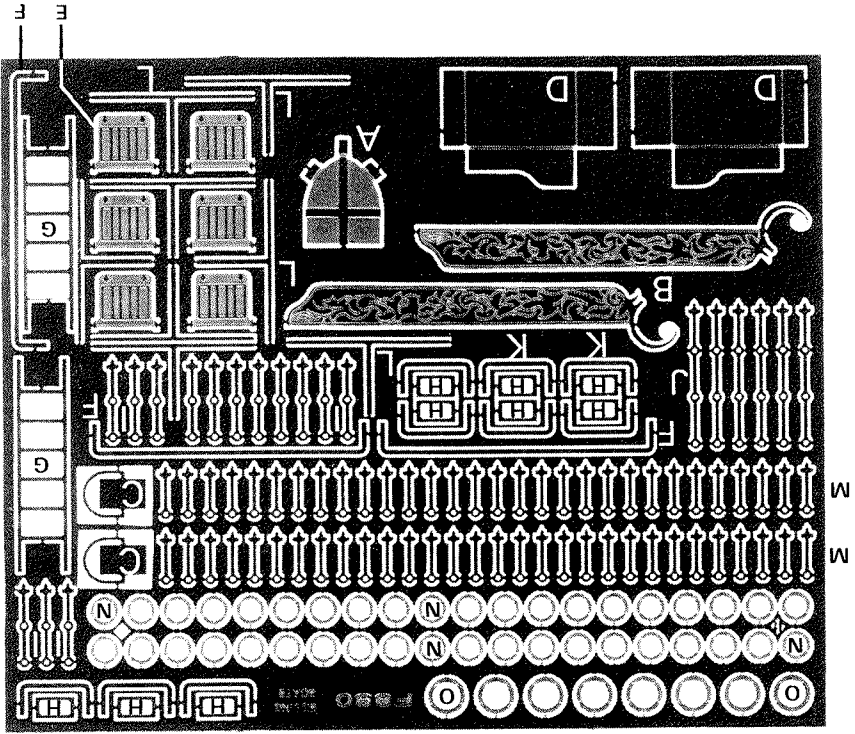

F881

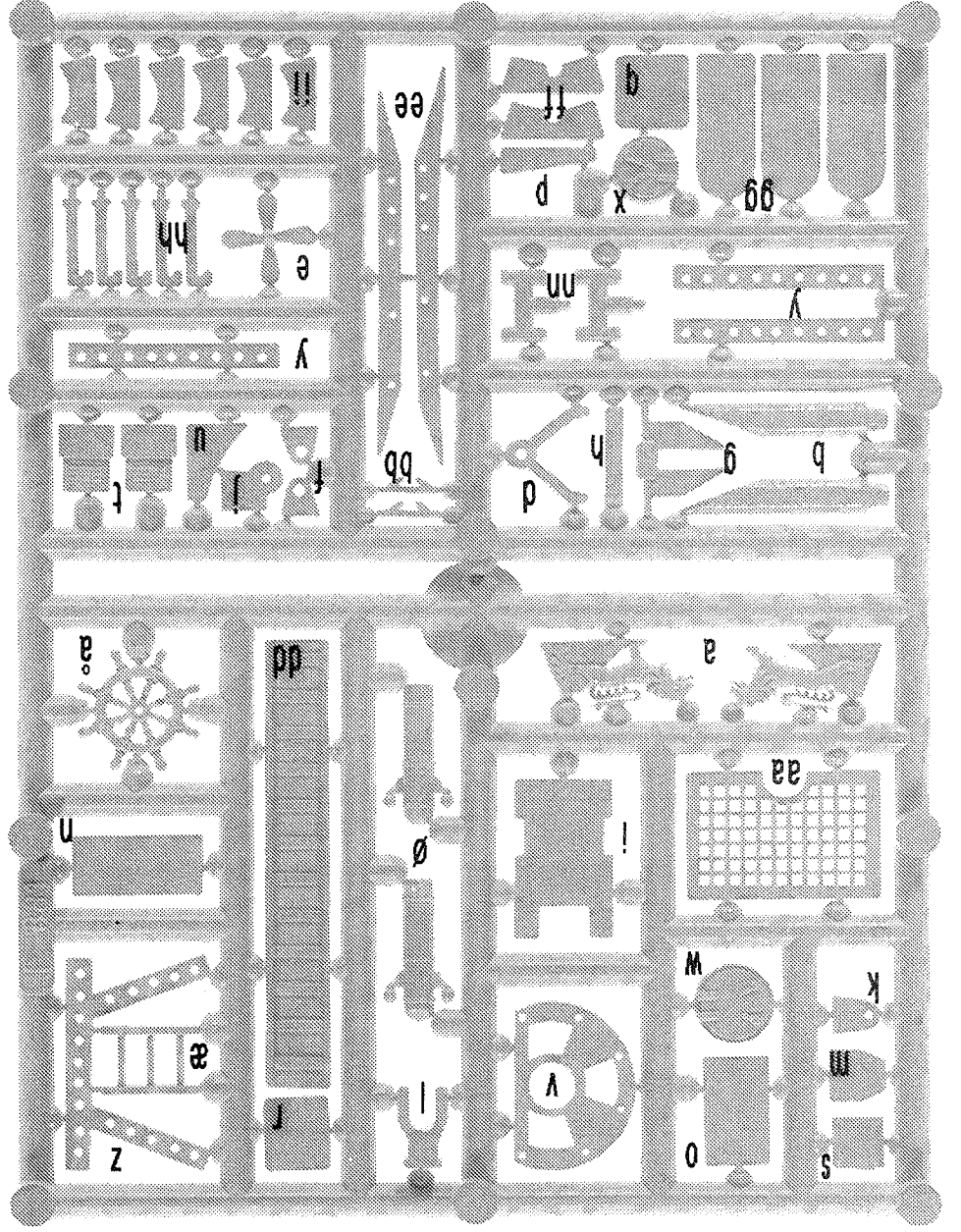

Table contents for "Sir Winston Churchill" Art. No. 706

Pcs.	No.	Dimension	Material	DK	GB	D	F
2	0a	2mm x-veneér	2142L	Styr	Guide	Führung	Guide
2	0	2mm x-veneér	2142L	Køl	Keel	Kiel	Quille
2	1	3mm x-veneér	2142L	Spant	Frame	Spant	Couples
2	2	3mm x-veneér	2142L	Spant	Frame	Spant	Couples
2	3	3mm x-veneér	2142L	Spant	Frame	Spant	Couples
2	4	3mm x-veneér	2142L	Spant	Frame	Spant	Couples
2	5	3mm x-veneér	2142L	Spant	Frame	Spant	Couples
2	6	3mm x-veneér	2142L	Spant	Frame	Spant	Couples
2	7	3mm x-veneér	2142L	Spant	Frame	Spant	Couples
2	8	3mm x-veneér	2142L	Spant	Frame	Spant	Couples
2	9	3mm x-veneér	2142L	Spant	Frame	Spant	Couples
2	10	3mm x-veneér	2142L	Spant	Frame	Spant	Couples
2	11	3mm x-veneér	2142L	Spant	Frame	Spant	Couples
2	12	3mm x-veneér	2142L	Spant	Frame	Spant	Couples
2	13	0,8mm x-veneér	2143L	Dæk	Deck	Deck	Pont
62	14	1,8x4x550mm	Obechi	Beklædningslister	Plankingstrips	Beplankungsleisten	Baguette de bordé
2	15	20x27x40mm	Balsa	Hækklods	Stern block	Heckklötze	Oviere poulie
1	16	0,8mm x-veneér	2143L	Hækspejl	Transom-stern	Heckspiegel	Arrière à tableau
1	17	0,8mm x-veneér	2143L	Skanseklædning	Formed pieces	Schanzkleid	Pièces préfabrique
20	18	0,7x2x550mm	Annegre	Dækslister	Deckstrips	Deckleisten	Barres
2	19	2mm x-veneér	2144L	Ræling	Rail	Reling	Plat bord
1	20	2mm x-veneér	2144L	Ræling	Rail	Reling	Plat bord
1	21	2mm x-veneér	2144L	Rorbeslag	Fittings for rudder	Ruderbeschlag	Garniture de gouvernail
2	22	2mm x-veneér	2141L	Ror	Rudder	Ruder	Gouvernail
2	23	1,8x2x550mm	Obechi	Fenderliste	Rubbing strake	Scheverleisten	Cienture
1	24	2mm x-veneér	2144L	Kahyt-Bundplade	Cabin-Sole plate	Kajüten-Boden	Trole borde des cabine fonds
1	25	3mm x-veneér	2142L	Kahyt-Skot	Cabinbulkhead	Kajüten-Schott	Cloison
1	26	3mm x-veneér	2142L	Kahyt-Skot	Cabinbulkhead	Kajüten-Schott	Cloison
1	27	3mm x-veneér	2142L	Kahyt-Skot	Cabinbulkhead	Kajüten-Schott	Cloison
1	28	2mm x-veneér	2144L	Kahyt-Tag	Cabin Roof	Kajüten-Dach	Cabine toit
1	29	2mm x-veneér	2144L	Kahyt-Dæk	Cabin Deck	Kajüten-Deck	Pont de cabine
1	30	0,8mm x-veneér	2143L	Kahyt-Side	Cabin Side	Kajüten-Seitenteile	Coté de cabine
1	30a	0,8mm x-veneér	2143L	Kahyt-Side	Cabin Side	Kajüten-Seitenteile	Coté de cabine
1	31	0,8mm x-veneér	2143L	Kahyt-Vindspejl	Cabin Windscreen	Kajüten-Windschutzscheibe	Cabine de parabrise
1	32	0,8mm x-veneér	2143L	Kahyt-Plade	Cabin plate	Kajüten-Platte	Plaque de cabine
1	33	0,8mm x-veneér	2143L	Kahyt-Plade	Cabin plate	Kajüten-Platte	Plaque de cabine
1	34	5mm x-veneér	2145L	Bedding	Slip	Ständer (Aufschleppe)	Cale
1	35	5mm x-veneér	2145L	Bedding	Slip	Ständer (Aufschleppe)	Cale
2	37		9047S	Presenning	Tarpaulin	Plane	Capot
1	38	1,8x3x550mm	Obechi	Cockpit-Ræling	Cockpit-Rail	Cockpit-Reling	Plat bord de cockpit
1	39	ø6x395mm	Ramin	Mast	Mast	Mast	Mât
2	40	ø6x385mm	Ramin	Mast	Mast	Mast	Mât

1	41	10x18x8mm	Obechi	Nedgang, Agter	Setting, Stern	Niedergang, achtern	Descente, arrière
1	42	6x6x50mm	Obechi	Cockpit-Ræling	Cockpit-Rail	Cockpit-Reling	Plat bord de cockpit
1	43	10x13x35mm	Obechi	Maskinskylight	Maschinskylight	Maschinen-Oberlicht	Claire-voie de mecanique
1	44	9x7x16mm	Obechi	Nedgang, for	Companion, fore	Niedergang, vorne	Couroir, devant
1	44a	19x16x7mm	Obechi	Nedgang, for	Companion, fore	Niedergang, vorne	Couroir, devant
1	44b	0,7x2x550mm	Mahogany	Nedgang, for	Companion, fore	Niedergang, vorne	Couroir, devant
1	45	11x8x11mm	Obechi	Bovsprydholder	Bowspritsupporter	Bugspriestütze	Support de Blaupré
1	46	M11	Ramin	Bovspryd	Bowsprit	Bugspriet	Blaupré
3	47	R4	Ramin	Bom	Boom	Baum	Bôme
1	48	R5	Ramin	Bom	Boom	Baum	Bôme
1	49	R5	Ramin	Bom	Boom	Baum	Bôme
1	50	R3	Ramin	Rå	Yard	Rahe	Vergue
1	51		TR134	Transfer	Transfer	Abziehbild	Decals
1	52		FL114	Flag	Flag	Flaggen	Drapeau
1	53		9047S	Sejl	Sail	Segel	Voil
1	54		FL138	Flag	Flag	Flaggen	Drapeau
1				Tegning	Drawing	Zeichnung	Plans
1				Byggevejledning	Building instr.	Bauanleitung	Instr. de montage

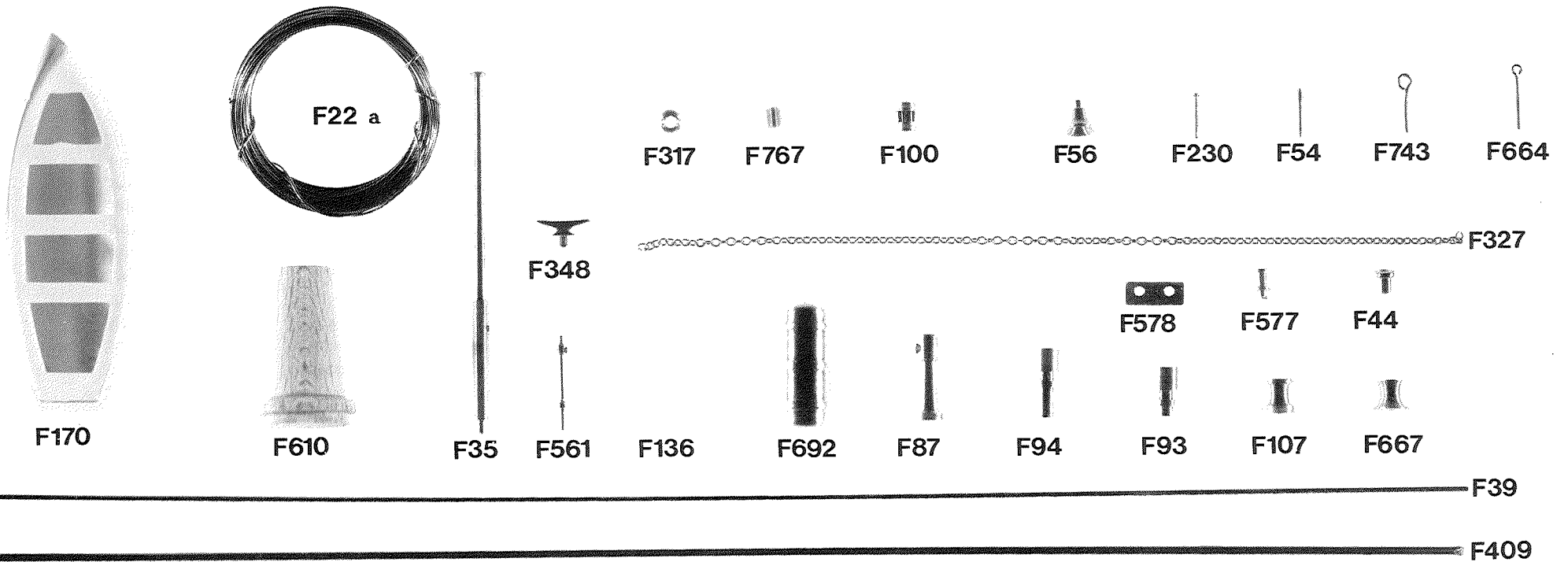

Table contents for fittingkit "Sir Winston Churchill"

Pcs.	No.	Dimension	DK	GB	D	F
1	F22a	0,5mm	Kobbertråd	Copper wire	Kupferdraht	Fil de cuivre
1	F35	ø3x61mm	Flagstang	Flagstaff	Fahnenmast	Hampre
1	F39	ø1x250mm	Messingtråd	Brass wire	Messingdraht	Fil de laiton
4	F44	4x4xmm	Bøsning	Bush	Buchse	Baque
57	F54	8mm	Kofilnagle	Belaying pins	Belegnägel	Cabillot
2	F56	ø5x5,5mm	Klokke	Bell	Glocke	Cloche
1	F71	30m	Rigningstråd	Rigging thread	Takelungsgarn	Fil de greement
1	F72	10m	Rigningstråd	Rigging thread	Takelungsgarn	Fil de greement
1	F87	15mm	Ratsøjle	Wheel column	Steuersäule	Colonne de Roue
7	F93	8x5mm	Ventil	Vent	Lüfter	Manche à air luchtkoker
4	F94	12x5mm	Ventil	Vent	Lüfter	Manche à air luchtkoker
5	F100	ø4mm	Lanterne	Light	Laterne	Lanterne
1	F107	ø6x6mm	Kapstan	Capstan	Kapstan	Cabestan
5	F136	ø10mm	Redningsbælte	Life-Belt	Rettungsringe	Ceinture de sauvetage
2	F170	64mm	Redningsbåd	Life-Boat	Rettungsboot	Chaloupe ponte
30	F230	ø0,8x7mm	Søm	Pins	Nägel	Clous
2	F317	ø4x2mm	Klyds	Fairlead	Klüsen	Ecubiérs
1	F327	120mm	Ankerkæde	Anchor cable	Ankerkette	Chaîne d'ancre
8	F348	9mm	Klampe	Cleats	Klampen	Taquets
3	F409	ø1,5x250mm	Messingtråd	Brass wire	Messingdraht	Fil de laiton
16	F561	ø2x14mm	Stolpe	Posts	Stütze	Socle
12	F577	ø3x3,5mm	Pullert	Bollard	Poller	Bitte d'amarrage
6	F578	10x4mm	Underlagsplade	Bearing plate	Basisplatte	Plaque support
2	F610	ø14x26mm	Træsokkel	Wood console	Holzsockel	Console de bois
70	F664	11mm	Øjebolt	Eye bolt	Ösenshraube	Pitons
4	F667	ø6x4,8mm	Spilkop	Warping end	Spillkopf	Tambour
6	F692	ø10x21mm	Redningsflåde	Liferaft	Rettungsfloß	Readeau de sauvetage
32	F743	9mm	Øjebolt	Eye bolt	Ösenshraube	Pitons
72	F767	4x2x2,5mm	Blok, enkel	Block, single	Block, einzeln	Poulie, simple
2	F879		Ætseplade	Etching plate	Ätzplatte	Planche gravée
1	F880		Ætseplade	Etching plate	Ätzplatte	Planche gravée
2	F881		Plaststøb	Plastic steep	Plastikspritling	Plastic moulage

Table contents for "Sir Winston Churchill" Art. No. 706

Pcs.	No.	Dimension	Material	NL	E	I	P
2	0a	2mm x-veneér	2142L	Geleider	Guía	Guida	Guia
2	0	2mm x-veneér	2142L	Kiel	Quilla	Chiglia	Quilha
2	1	3mm x-veneér	2142L	Spanten	Cuaderna	Ordinata	Armação
2	2	3mm x-veneér	2142L	Spanten	Cuaderna	Ordinata	Armação
2	3	3mm x-veneér	2142L	Spanten	Cuaderna	Ordinata	Armação
2	4	3mm x-veneér	2142L	Spanten	Cuaderna	Ordinata	Armação
2	5	3mm x-veneér	2142L	Spanten	Cuaderna	Ordinata	Armação
2	6	3mm x-veneér	2142L	Spanten	Cuaderna	Ordinata	Armação
2	7	3mm x-veneér	2142L	Spanten	Cuaderna	Ordinata	Armação
2	8	3mm x-veneér	2142L	Spanten	Cuaderna	Ordinata	Armação
2	9	3mm x-veneér	2142L	Spanten	Cuaderna	Ordinata	Armação
2	10	3mm x-veneér	2142L	Spanten	Cuaderna	Ordinata	Armação
2	11	3mm x-veneér	2142L	Spanten	Cuaderna	Ordinata	Armação
2	12	3mm x-veneér	2142L	Spanten	Cuaderna	Ordinata	Armação
2	13	0,8mm x-veneér	2143L	Dek	Cubierta	Ponte	Deck
62	14	1,8x4x550mm	Obechi	Beplankings strips	Listones de forro	Listello per fasciame	Tira de revestimento
2	15	20x27x40mm	Balsa	Achtersteven blokken	Taco de popa	Blocchetti per la poppa	Bloco de popa
1	16	0,8mm x-veneér	2143L	Platte Spiegel	Especjo de popa	Specchio di poppa	Espelho de popa
1	17	0,8mm x-veneér	2143L	Gevormd deel	Regala	Parapetto di murata	Baluarde
20	18	0,7x2x550mm	Annegre	Dekstrips	Listones de la cubierta	Listelli ponte	Tiras de entabuamento
2	19	2mm x-veneér	2144L	Reling	Borda	Parapetto	Amurada
1	20	2mm x-veneér	2144L	Reling	Borda	Parapetto	Amurada
1	21	2mm x-veneér	2144L	Beslag-roer	Herrajes de Timón	Accessori timone	Fittings para o leme
2	22	2mm x-veneér	2141L	Roer	Timón	Timone	Leme
2	23	1,8x2x550mm	Obechi	Berghout	Liston de defensa	Listello parabordo	Cinto de borracha
1	24	2mm x-veneér	2144L	Kajuit bodem plaat	Placa fondo de camarote	Cabina-Base per bitta	Cabine-Placa de base de montagem
1	25	3mm x-veneér	2142L	Kajuitschot	Mamparo de camarote	Cabina-Paratia	Cabine-Paredes divisórias
1	26	3mm x-veneér	2142L	Kajuitschot	Mamparo de camarote	Cabina-Paratia	Cabine-Paredes divisórias
1	27	3mm x-veneér	2142L	Kajuitschot	Mamparo de camarote	Cabina-Paratia	Cabine-Paredes divisórias
1	28	2mm x-veneér	2144L	Kajuit	Techo de camarote	Cabina-Tetto	Cabine-Teto
1	29	2mm x-veneér	2144L	Kajuitdek	Cubierta de camarote	Cabina-Ponte	Cabine-Deck
1	30	0,8mm x-veneér	2143L	Zijkanten kajuit	Lados de camarote	Cabina-Pezzi laterali	Cabine-Lateral
1	30a	0,8mm x-veneér	2143L	Zijkanten kajuit	Lados de camarote	Cabina-Pezzi laterali	Cabine-Lateral
1	31	0,8mm x-veneér	2143L	Kajuitscherm	Camarote de parabrisas	Cabina-Parabrezza	Cabine-Parabrisa
1	32	0,8mm x-veneér	2143L	Plaat kajuit	Placa de camarote	Cabina-Asse	Cabine-Placa
1	33	0,8mm x-veneér	2143L	Plaat kajuit	Placa de camarote	Cabina-Asse	Cabine-Placa
1	34	5mm x-veneér	2145L	Stander	Grada	Supporto	Apoio
1	35	5mm x-veneér	2145L	Stander	Grada	Supporto	Apoio
2	37		9047S	Presenning	Tela impermeable	Tela olona	Lona do bote
1	38	1,8x3x550mm	Obechi	Kuip-Reling	Bañera-borda	Parapetto posto di comando	Amurada da ponte
1	39	ø6x395mm	Ramin	Mast	Palo	Albero	Mastro
2	40	ø6x385mm	Ramin	Mast	Palo	Albero	Mastro

Table contents for fittingkit "Sir Winston Churchill"

Pcs.	No.	Dimension	NL	E	I	P
1	F22a	0,5mm	Koperdraad	Hilo de cobre	Filo in rame	Linha de cobre
1	F35	ø3x61mm	Vlaggestok	Asta de bandera	Asta portabandiera	Haste da bandeira
1	F39	ø1x250mm	Messingdraad	Hilo de latón	Filo in ottone	Fio de latão
4	F44	4x4xmm	Bus	Casquillo	Copertura	Anel
57	F54	8mm	Korvijnägel	Cabilla	Ribattino	Cavilhas
2	F56	ø5x5,5mm	Scheepsbei	Campanilla	Campana	Sino
1	F71	30m	Takelgaren	Hilo de arboladura y de jarcía	Filo per manovre	Linha de cordame
1	F72	10m	Takelgaren	Hilo de arboladura y de jarcía	Filo per manovre	Linha de cordame
1	F87	15mm	Stuurwiel zuil	Columna de volante	Supporto ruota	Suporte do timão
7	F93	8x5mm	Luchtkoker	Válvula	Valvola	Respiradouro
4	F94	12x5mm	Luchtkoker	Válvula	Valvola	Respiradouro
5	F100	ø4mm	Boordlichten	Linterna	Lanterna di bordo	Luzes
1	F107	ø6x6mm	Gangspil	Cabrestante	Argano	Cabrestante
5	F136	ø10mm	Reddingsboei	Cinturón salvavidas	Cintura di salvataggio	Bóias salva-vidas
2	F170	64mm	Reddingsboot	Bote salvavidas	Battello di salvataggio	Barco salva-vidas
30	F230	ø0,8x7mm	Spijkertjes	Clavos	Chiodi	Pino
2	F317	ø4x2mm	Kluisgat	Galápago	Rinforzo	Tube do escovém
1	F327	120mm	Ankerketting	Cadena de ancla	Catena ancora	Corrente da âncora
8	F348	9mm	Kickers	Cornamusa	Galloccia	Ponto de amarra
3	F409	ø1,5x250mm	Messingdraad	Hilo de latón	Filo in ottone	Fio de latão
16	F561	ø2x14mm	Paal	Poste	Supporto	Poste
12	F577	ø3x3,5mm	Bolder	Bitón	Bitta	Abita
6	F578	10x4mm	Onderlegplaat	Placa de soporte	Asse di base	Placa de apoio
2	F610	ø14x26mm	Hout console	Base de madera	Zoccolo in legno	Console de madeira
70	F664	11mm	Oogbouten	Cáncamo	Bullone ad occhio	Ferrolho
4	F667	ø6x4,8mm	Spilkop	Tambor de cabrestante	Testa argano	Terminal
6	F692	ø10x21mm	Reddingsvlot	Balsa salvavidas	Zattera di salvataggio	Salva-vidas
32	F743	9mm	Oogbouten	Cáncamo	Bullone ad occhio	Ferrolho
72	F767	4x2x2,5mm	Blok, eenschijfs	Polea, simple	Blocchi (semplici)	Blocos Simples
2	F879		Etsplaat	Placa de corrosion	Lastra per incisione	Placa de corrosão
1	F880		Etsplaat	Placa de corrosion	Lastra per incisione	Placa de corrosão
2	F881		Plastiek, giet	Piezas de plástico fundido	Pezzo stampato a iniezione	Plástico moldado

1	41	10x18x8mm	Obechi	Ondergang, achter	Bajada, popa	Boccaporto a poppa	Escada de descida, popa
1	42	6x6x50mm	Obechi	Kuip-Reling	Bañera-borda	Parapetto posto di comando	Amurada da ponte
1	43	10x13x35mm	Obechi	Machine bovenlicht	Lumbrera de máquina	Osteriggio vano motore	Clarabóia da máquina
1	44	9x7x16mm	Obechi	Kajuitstrap, voor	Bajada, proa	Boccaporto a prua	Escada de descida, proa
1	44a	19x16x7mm	Obechi	Kajuitstrap, voor	Bajada, proa	Boccaporto a prua	Escada de descida, proa
1	44b	0,7x2x550mm	Mahogany	Kajuitstrap, voor	Bajada, proa	Boccaporto a prua	Escada de descida, proa
1	45	11x8x11mm	Obechi	Boegspriet steunen	Sujetador de Bauprés	Supporto del bompresso	Apoio do gurupés
1	46	M11	Ramin	Boegspriet	Bauprés	Albero di bompresso	Gurupés (mastro de proa)
3	47	R4	Ramin	Boom	Botavara	Asta	Botaló
1	48	R5	Ramin	Boom	Botavara	Asta	Botaló
1	49	R5	Ramin	Boom	Botavara	Asta	Botaló
1	50	R3	Ramin	Ra	Verga	Pennone	Verga
1	51		TR134	Transfer	Transfer	Decalcomanie	Transfers
1	52		FL114	Vlag	Bandera	Bandiere	Bandeira
1	53		9047S	Zeil	Vela	Vela	Vela
1	54		FL138	Vlag	Bandera	Bandiere	Bandeira
1				Tekeningen	Ilustración	Piani di costruzione	Planta principal
1				Bouwbeschrijving	Instrucciones de construccion	Istruzioni di montaggio	Instruções de construção